

# High performance liquid-solids separation systems

# JPL

Exclusive internal acceleration creates maximum performance to achieve maximum protection of fluid handling systems from unwanted solids (see illustration inside for details). Its advanced & patented design, building upon the performance LAKOS is known for, now also removes 50% more of the finer solids (< 40 microns), resulting in higher aggregate solids removal. Independently tested. Proven superior for today's demanding filtration requirements. For settleable solids only.

Trouble-free operation & advanced purging/solids-handling concepts keep fluids clean and concentrate separated solids

No screens or filter elements to clean or replace; no messy servicing routines

No backwashing; zero fluid loss options

Low & steady pressure loss

Choice of profiles to accommodate space/piping limitations

Swirlax internal accelerating slots for optimum solids-removal performance; patented

Vortube for enhanced solids separation/collection; patented

Grooved inlet/outlet connections for easy installation; optional flanged connections also available

In-line inlet/outlet configuration for simplified piping (low-profile models only)

Unishell construction for easy installation

Optional material construction & ASME code

Flow range:  
4 - 12,750 U.S. gpm  
(1 - 2895 m<sup>3</sup>/hr) per unit

Maximum standard pressure rating:  
150 psi (10.3 bar)  
at 180° F (82° C)



JPL Series includes inlet/outlet pressure gauges with petcock valves.



Also available with weld-on flanges. See page 3 for other details.



How-it-Works Illustration

Model Specifications

Installation & Operating Instructions

Maintenance & Purging

Engineering Specifications

## How It Works

### Automatic Purging

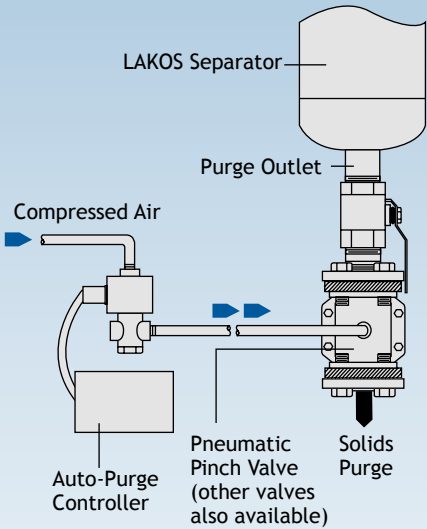

### Solids Handling Options

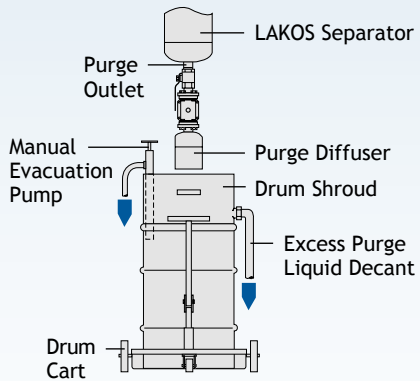

Systems also available with a tilt-style hopper.

Lakos Separators are manufactured and sold under one or more of the following U.S. Patents:  
 5,320,747; 5,338,341; 5,368,735;  
 5,425,876; 5,571,416; 5,578,203;  
 5,622,545; 5,653,874; 5,894,995;  
 6,090,276; 6,143,175; 6,167,960;  
 6,202,543; 7,000,782; 7,032,760 and  
 corresponding foreign patents, other  
 U.S. and foreign patents pending.

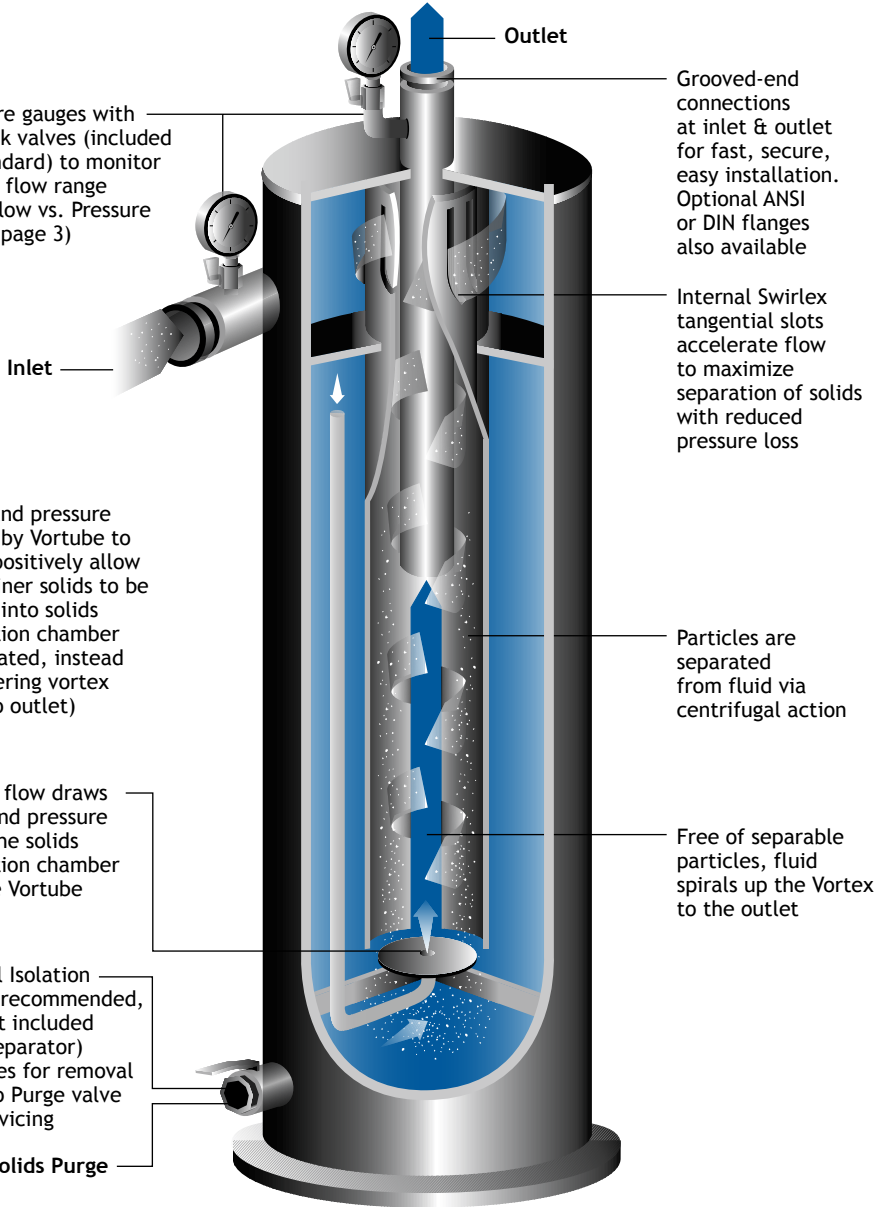

## Performance

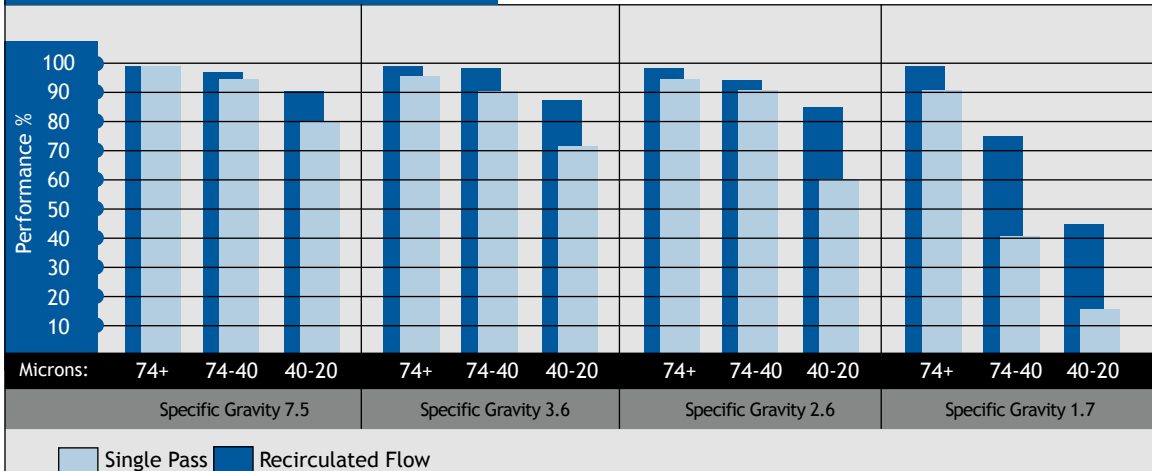

# Specifications

Model*	Flow Range		Inlet/Outlet Grooved Coupling**	Purge Size Male N.P.T.	Collection Chamber Capacity		Weight Empty		Weight with Water	
	U.S. gpm	m <sup>3</sup> /hr			gal	liters	lbs.	kg	lbs	kg
JPL-0004	4-10	1-2.5	1/2" NPT**	1"	0.09	0.3	23	10.4	29	13.2
JPL-0010	10-20	2.5-4.5	3/4" NPT**	1"	0.11	0.4	37	16.8	47	21.3
JPL-0016	16-30	4-7	1"	1"	0.15	0.6	43	19.5	53	24
JPL-0028	28-45	7-10	1-1/4"	1-1/2"	0.27	1.0	62	28.1	80	36.3
JPL-0038	38-65	9-15	1-1/2"	1-1/2"	0.4	1.5	86	39.0	115	52.2
JPL-0060	60-100	14-23	2"	1-1/2"	0.8	3.0	147	66.7	218	98.9
JPL-0085	85-145	19-33	2-1/2"	1-1/2"	0.8	3.0	189	85.7	272	123.4
JPL-0130	130-225	30-51	3"	1-1/2"	0.8	3.0	200	90.7	288	130.6
JPL-0200-L	200-325	45-74	4"	1-1/2"	1.6	6.1	425	192.8	617	279.9
JPL-0200-V					4.4	16.7	368	166.9	582	264.0
JPL-0285-L	285-525	65-120	4"	1-1/2"	2.1	7.9	558	253.1	869	394.2
JPL-0285-V					5.4	20.5	468	212.3	752	341.1
JPL-0450-L	450-825	102-190	6"	1-1/2"	2.8	10.6	720	326.6	1195	542.0
JPL-0450-V					6.7	25.4	645	292.6	1090	494.4
JPL-0650-L	650-1200	150-275	6"	1-1/2"	4.3	16.3	924	419.1	1622	735.7
JPL-0650-V					10.4	39.4	880	399.2	1536	696.7
JPL-1160-L	1160-2150	265-490	8"	1-1/2"	8.6	32.6	1309	593.7	2634	1194.8
JPL-1160-V					20.5	77.6	1304	591.5	2558	1160.3
JPL-1850-L	1850-3400	420-775	10"	2"	15.0	56.8	1732	785.6	3874	1757.2
JPL-1850-V					31.5	119.2	1829	829.6	3843	1743.1
JPL-2650-L	2650-4900	600-1115	12"	2"	23.5	89.0	2641	1197.9	7025	3186.5
JPL-2650-V					51.1	193.4	2331	1057.3	5821	2640.3
JPL-4200-L	4200-7800	950-1775	16"	3"	52.2	197.6	5120	2322.4	12131	5502.5
JPL-4200-V					99.3	375.9	4675	2120.5	11886	5391.4
JPL-6700-L	6700-12750	1520-2895	20"	3"	81.0	306.6	6983	3167.4	18332	8315.2
JPL-6700-V					162.3	614.4	6594	2990.9	18061	8192.3

\* Models ending with "L" are low profile, "V" for vertical profile. No suffix indicates low-flow vertical profile

\*\* Inlet/Outlet may also be specified with ANSI or DIN flanges; other models also available with optional threading

Maximum pressure rating: 150 psi (10.3 bar); consult factory for higher pressure requirements

Maximum temperature rating: 180°F (82.2°C) Consult factory for higher temperatures

Pressure loss range: 3 - 12 psi (.2-.8 bar)

Maximum particle size: JPL-0016 and smaller - .25 inch (6 mm); all other models - .375 inch (9 mm)

Material (standard carbon steel): Domes - A 285C/516 GR70, .25 inch (6 mm) minimum thickness

Other parts - A-36, A-53B or other quality grade, .25 inch (6 mm) minimum thickness; special coatings

and other materials available - consult factory

Paint coating: Acrylic urethane, spray-on royal blue

## Flow vs. Pressure Loss

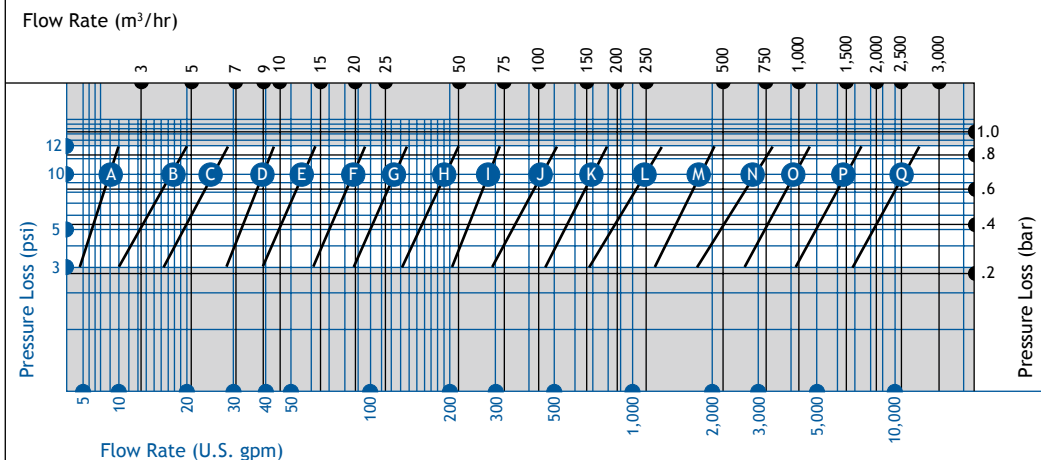

- A JPL-0004
- B JPL-0010
- C JPL-0016
- D JPL-0028
- E JPL-0038
- F JPL-0060
- G JPL-0085
- H JPL-0130
- I JPL-0200
- J JPL-0285
- K JPL-0450
- L JPL-0650
- M JPL-1160
- N JPL-1850
- O JPL-2650
- P JPL-4200
- Q JPL-6700

## Installation Instructions

### Maintenance/Purging

1. LAKOS JPL Separators must be purged regularly to remove the separated solids from the temporary collection chamber.
2. All purge hardware should be installed prior to any elbows or turns in the purge piping. Avoid "uphill" purging, which can clog purge piping and hinder effective solids evacuation.
3. For best results, purging is recommended while the LAKOS Separator is in operation, utilizing system pressure to enhance solids evacuation.
4. LAKOS provides a full selection of rugged, durable automatic purging and solids-handling systems to optimize the performance of your separation system. **CAUTION:** Economy-type valves typically fail prematurely in the harsh/abrasive environment of solids purging.
5. Be sure to install the manual isolation valve (provided as standard) prior to the automatic valve (available from LAKOS at additional cost) in order to facilitate servicing of the automatic valve without system shutdown.

- 1 LAKOS JPL Separators are shipped on skids or in wooden crates. Support legs (when applicable) are detached for shipping. A large ring, located on the unit's side or upper chamber, is provided for hoisting as necessary.
- 2 A suitable foundation is necessary to accommodate the LAKOS Separator's weight including liquid (see data, page 3). Anchor bolts are recommended in the base of the legs (low profile) or skirt (vertical profile).
- 3 Prior to installation, inspect the inlet/outlet/purge connections for foreign objects incurred during shipping/storage.
- 4 Inlet/outlet pipe connections to the LAKOS Separator should be a straight run of at least five pipe diameters to minimize turbulence and enhance performance. Separators should not support piping.
- 5 Proper purge hardware and/or solids-handling equipment is required to flush separated solids from the separator (see details, page 2).
- 6 All LAKOS Separators operate within a prescribed flow range (see data, page 3). Pipe size is not a factor in model selection. Use appropriate hardware to match the inlet/outlet size. Grooved couplings are not included with the separator. Optional flanged connections are available upon request.
- 7 Inlet pressure to the LAKOS Separator must be at least equal to or greater than the anticipated pressure loss through the separator (see pressure loss chart, page 3) plus 15 psi (1 bar) plus whatever downstream pressure is required.
- 8 Pressure gauges (provided as standard, with petcock valves) are required at both the inlet and outlet of the separator in order to monitor pressure loss and proper system flow (see "Flow vs. Pressure Loss" chart, page 3). If separator operates with an open discharge, a valve should be installed to create a back pressure of at least 5 psi (.3 bar).
- 9 Winterizing is important if the LAKOS Separator is to remain idle in freezing temperatures. Drain liquid as necessary to avoid expansion of water to ice and related damages.
- 10 See I & O Manual for additional information of standard units.

## Low Flow Rates

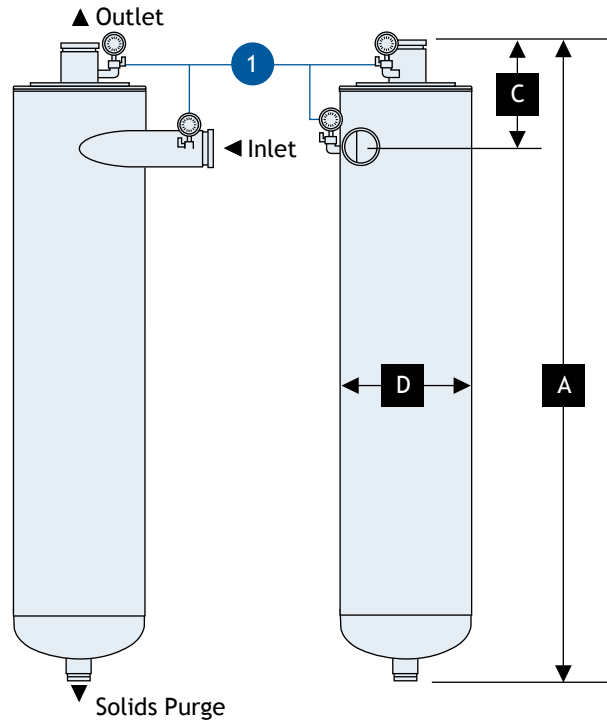

Top View

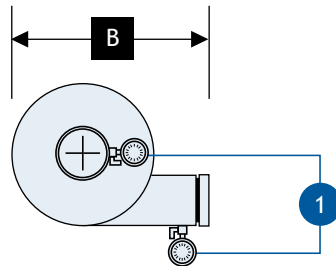

## Dimensions

Model	A		B		C		D	
	in	mm	in	mm	in	mm	in	mm
JPL-0004	27-9/16	699	6-3/4	171	7-5/8	194	3-1/2	89
JPL-0010	31-13/16	808	8-1/4	210	7-5/8	194	4-1/2	114
JPL-0016	33-1/8	842	8-1/4	210	7-15/16	202	4-1/2	114
JPL-0028	36-15/16	938	9-13/16	249	8-1/16	205	5-9/16	141
JPL-0038	39-1/2	1003	10-5/16	262	8-1/8	206	6-5/8	168
JPL-0060	48-13/16	1239	13-5/16	338	8-7/8	225	8-5/8	219
JPL-0085	56-5/8	1438	13-5/16	338	9-5/8	244	8-5/8	219
JPL-0130	59-3/4	1517	13-5/16	338	10-1/2	267	8-5/8	219

### Inlet/Outlet Pressure Gauges with Petcock Valves

Included as standard; Install at both inlet and outlet for proper flow verification (see "Flow vs. Pressure Loss", page 3)

Note: These units may also be specified with optional support skirt or legs. Consult factory for details.

*Dimensions for reference only.  
Consult factory when pre-plumbing.*

## Low Profile

## High Flow Rates

### Inlet/Outlet Pressure Gauges with Petcock Valves

Included as standard; install at both inlet and outlet for proper flow verification (see "Flow vs. Pressure Loss", page 3)

### Inspection/Drain Plug

1/2-inch NPT female; provides access to upper chamber for inspection of slot area; also allows for draining the upper chamber if necessary

### Hand-Hole Inspection Port

Provides access to collection chamber

### Lifting Ring

For installation purposes

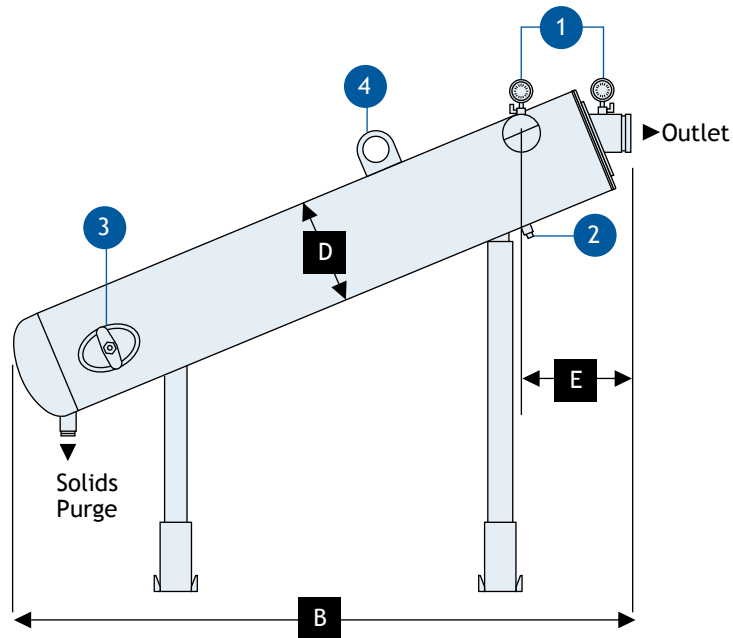
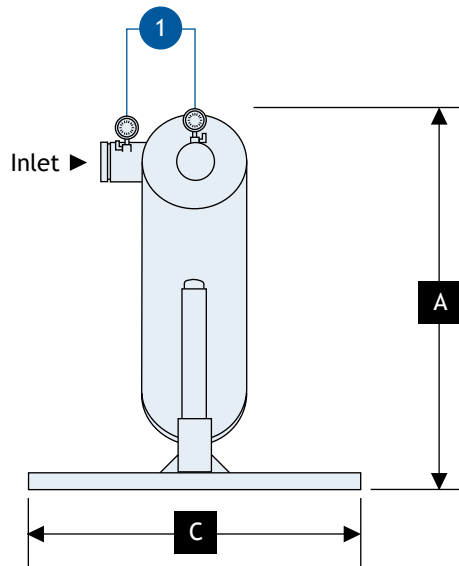

## Dimensions

Model	A		B		C		D		E	
	in	mm	in	mm	in	mm	in	mm	in	mm
JPL-0200-L	68-7/8	1749	65-1/2	1664	40	1016	10-3/4	273	13-1/4	337
JPL-0285-L	76-1/2	1943	79-3/4	2026	40	1016	12-3/4	324	15-7/8	403
JPL-0450-L	83-3/8	2118	94-1/2	2400	40	1016	14	356	15-1/4	387
JPL-0650-L	89-7/8	2283	106-1/4	2699	40	1016	16	406	17-7/8	454
JPL-1160-L	101-5/16	2573	127-1/4	3232	40	1016	20	508	21-13/16	554
JPL-1850-L	110	2794	142-3/8	3616	40	1016	24	610	25-15/16	659
JPL-2650-L	122-7/8	3121	157-1/2	4001	60	1524	28	711	28-3/16	716
JPL-4200-L	144-3/4	3677	197-1/2	5017	60	1524	36	914	37-1/8	943
JPL-6700-L	163-1/2	4153	233-5/8	5934	60	1524	42	1067	42-5/8	1083

Dimensions for reference only.  
Consult factory when pre-plumbing.

# High Flow Rates

# Vertical Profile

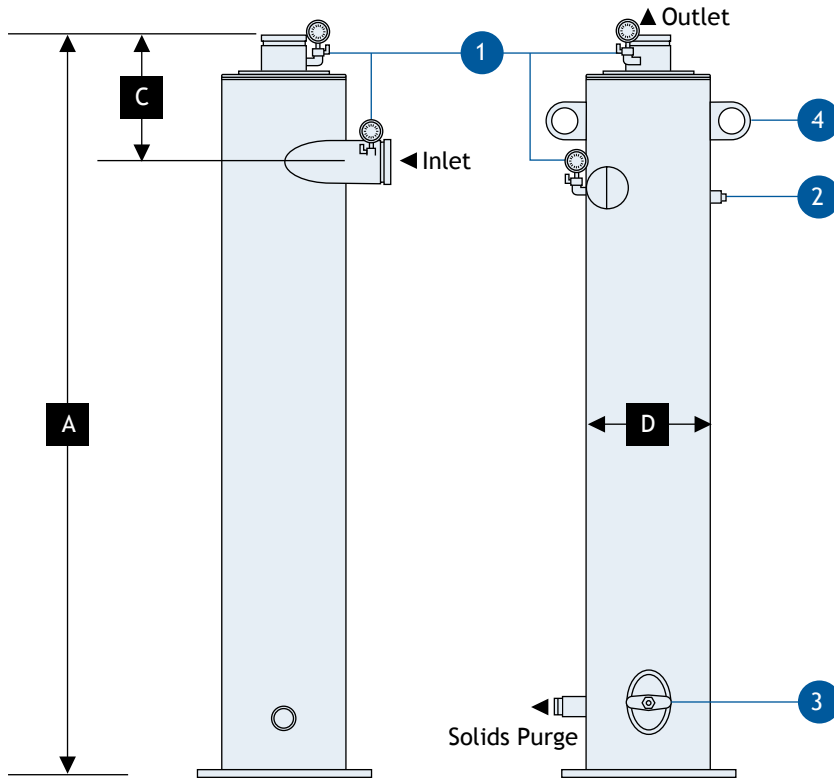

## 1 Inlet/Outlet Pressure Gauges with Petcock Valves

Included as standard; Install at both inlet and outlet for proper flow verification (see “Flow vs. Pressure Loss”, page 3)

## 2 Inspection/Drain Plug

1/2-inch NPT female; provides access to upper chamber for inspection of slot area; also allows for draining the upper chamber if necessary

## 3 Hand-Hole Inspection Port

Provides access to collection chamber

## 4 Lifting Rings

For installation purposes

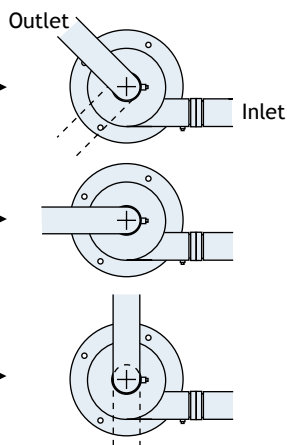

Recommended Direction of Inlet/Outlet Piping to Control Vibration

## Top Views

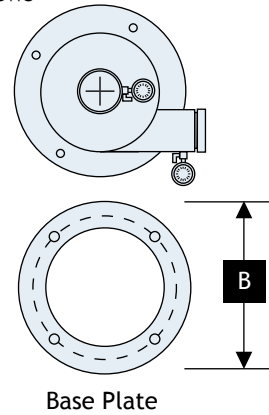

## Dimensions

Model	A		B		C		D	
	in	mm	in	mm	in	mm	in	mm
JPL-0200-V	74-1/6	1881	16	406	11-3/4	298	10-3/4	273
JPL-0285-V	79-13/16	2027	18	457	14-3/16	360	12-3/4	324
JPL-0450-V	94-7/8	2410	20	508	13-3/8	340	14	356
JPL-0650-V	107-3/8	2727	22	559	15-3/4	400	16	406
JPL-1160-V	128-1/8	3254	26	660	18-7/8	479	20	508
JPL-1850-V	141-1/4	3588	32	813	20-7/8	530	24	610
JPL-2650-V	161-1/2	4102	36	914	22-3/4	578	28	711
JPL-4200-V	202-3/4	5150	44	1118	29-1/8	740	36	914
JPL-6700-V	229-7/16	5828	48	1219	31-5/8	803	42	1067

Dimensions for reference only. Consult factory when pre-plumbing.

## Sample Specifications

## Limited Warranty

All products manufactured and marketed by this corporation are warranted to be free of defects in material or workmanship for a period of at least one year from date of delivery. Extended warranty coverage applies as follows:

All LAKOS Separators: Five year warranty

All other components: 12 months from date of installation; if installed 6 months or more after ship date, warranty shall be a maximum of 18 months from ship date.

If a fault develops, notify us, giving a complete description of the alleged malfunction. Include the model number(s), date of delivery and operating conditions of subject product(s). We will subsequently review this information and, at our option, supply you with either servicing data or shipping instruction and returned materials authorization. Upon prepaid receipt of subject product(s) at the instructed destination, we will then either repair or replace such product(s), at our option, and if determined to be a warranted defect, we will perform such necessary product repairs or replace such product(s) at our expense.

This limited warranty does not cover any products, damages or injuries resulting from misuse, neglect, normal expected wear, chemically-caused corrosion, improper installation or operation contrary to factory recommendation. Nor does it cover equipment that has been modified, tampered with or altered without authorization.

No other extended liabilities are stated or implied and this warranty in no event covers incidental or consequential damages, injuries or costs resulting from any such defective product(s).

Sample specifications can be downloaded from the LAKOS website at [www.LAKOS.com](http://www.LAKOS.com).

## Two-Stage Separators

**Effectively handles higher solids concentrations.  
Improves fine particle removal performance.**

Combining LAKOS Separators in a “Super Separator” configuration, the first-stage separator will always most effectively remove larger solids, which are easily influenced by centrifugal action. Often, it is the larger solids that make up a great percentage of the overall solids volume. When finer, yet separable solids are also present and larger solids have limited the space available on the perimeter of the separation barrel, the second-stage separator then performs to remove even more of the finer solids.

Essentially, removing the larger solids in the first-stage separator effectively reduces the overall solids concentration, allowing the second-stage separator to more easily handle the lower solids concentration and the smaller particles. And, in applications where the particle geometry is flakes, rods and/or irregular shapes, two-stage separators have been utilized to successfully increase overall particle-removal.

**JPL Low Profile**

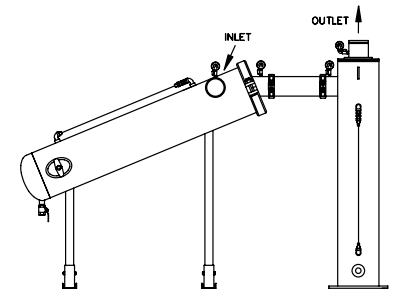
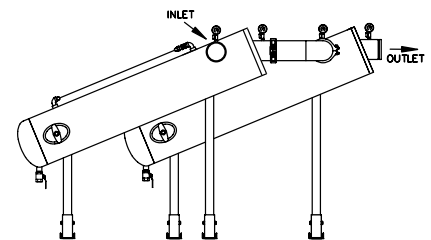

**JPX Low Profile with  
JPL Vertical Profile**